

**OPRAWA PARKOWA LED**
**KARTA KATALOGOWA**

# GAMMA 85

**oprawa LED COB 85W/230V IP65**







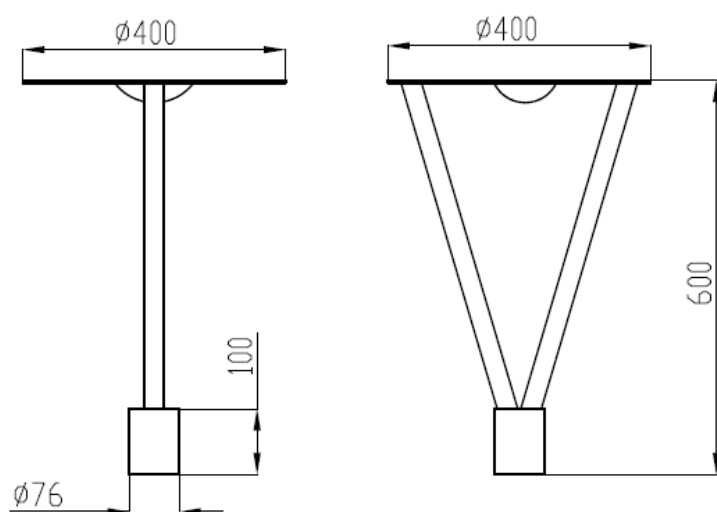

Lampa stosowana do oświetlenia ulic, placów, podjazdów, ogrodów, parków, parkingów oraz innych miejsc, gdzie potrzebne jest dobre oświetlenie zamontowane na słupie oświetleniowym. Idealne rozwiązanie, gdzie występuje konieczność oszczędzania energii.



PARAMETR TECHNICZNY	WARTOŚĆ
barwa światła	biała neutralna; 4500K (RA>75)
luminacja (całk. strumień światła)	8500 lm
kąt świecenia	60 stopni x120 stopni
ilość diod/typ	1/COB AC
wymiary (W/D/S)	400x400x600 mm
waga	2,7 kg
obudowa	aluminium
klasa szczelności	IP65
napięcie zasilania	180-260V AC
moc	85W
certyfikaty	CE, RoHS
żywność	>50.000 godzin
montaż	nasadzanie na słup fi 60 mm
czujnik zmierzchu	w opcji
kolor	standard RAL9005 lub 9006*

\* możliwe malowanie na inny kolor RAL

**WYMIARY (MM)**

			
AC 230V	COB LED	120°	IP 65
			
70	50000 h	0,95	IN&OUT
